

DISTRICT EIGHT

2022 COLLECTION

JOSS COLLECTION



designed by
TOAN NGUYEN

**WE DESIGN AND CREATE
QUALITY FURNITURE INSPIRED
BY VIETNAMESE HERITAGE FOR
MODERN-DAY LIVING.**

District Eight is a furniture brand established in 2010 in Ho Chi Minh City, Vietnam. The name refers to one of the city's 24 districts, in the heart of which we set up our first factory and office. We design and build insightful products that tell a story unique to Vietnam's enchanting landscape, with a confident take on contemporary living and an understanding of modern elegance.





Vuong's Palace
Hà Giang, Vietnam

N 23° 15' 24''
E 105° 15' 43''

JOSS COLLECTION

Designed by
TOAN NGUYEN



Joss solid wood bases, whose natural tones are the result of a process developed by District Eight, are characterized by an upper curvature, a declared reference to ancestral elements of Southeast Asian architecture. The complementarity of the generous foam volumes with the wooden bases, in perfect continuity, not only gives this resolutely contemporary collection a strong identity but also demonstrates the precision and attention to detail of District Eight's production.







The ample cushioning in Joss's extra-deep seatings are designed in complement to its ergonomically built backrest to emphasize comfort in exceptional volumes and upholstery. Carefully crafted pipping lines run along the sofa's edge to call attention to the curvature silhouette.



MATERIAL FEATURES

Materials and finishes are available to select from our standard index. Presented here are recommended variations.



Upholstery
Wood

Tara Ivory
Ebonized Oak

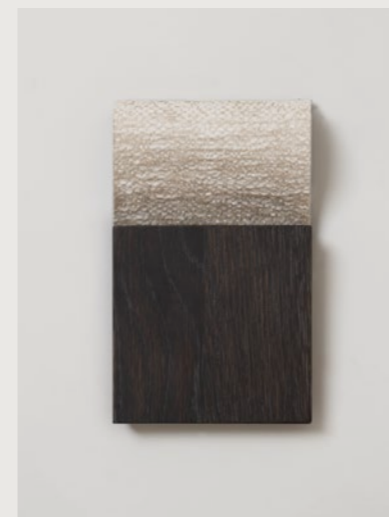

Tara Quartz
Ebonized Oak



Tara Ivory
Ebonized Oak



Tara Quartz
Smoke Oak



Tara Quartz
Charred Black Oak



Tara Ivory
Charred Black Oak



Tara Flint
Charred Black Oak



MODULAR SYSTEM

Joss lineup consists of 9 individual components, including a daybed and a table, which can be adapted to the changing and varied needs of spaces with combinations in various formats. Each piece of the collection profiles a sculptural expression that unites function and form in unprecedented ways.

Each piece of the collection profiles a sculptural expression that unites function and form in unprecedented ways.

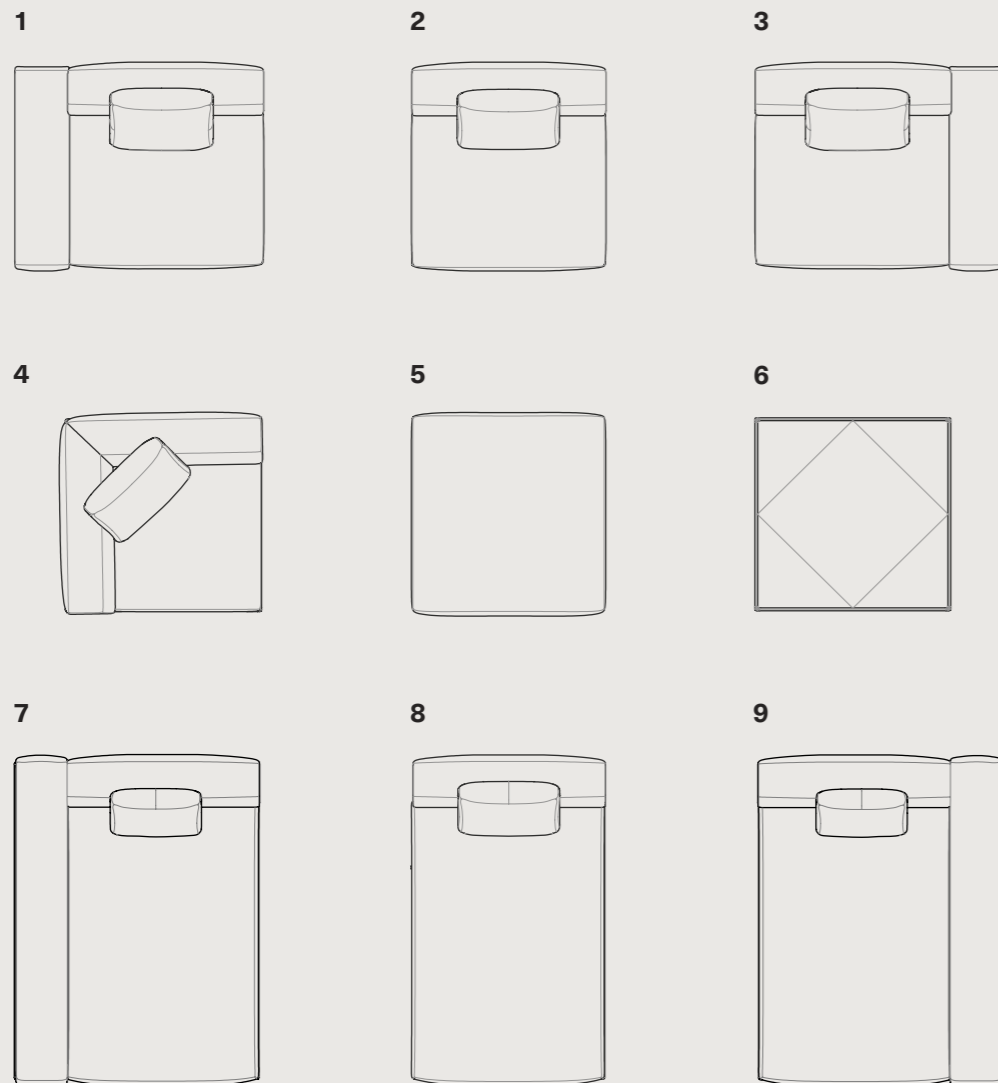

1. **Joss 1 Seater Left Arm**
M2019-LA
2. **Joss 1 Seater Armless**
M2019-NA
3. **Joss 1 Seater Right Arm**
M2019-RA
4. **Joss 1 Seater Corner**
M2019-C
5. **Joss Ottoman**
M2019-O
6. **Joss Table**
M1014
7. **Joss Daybed Left Arm**
M2019-LDB
8. **Joss Daybed Armless**
M2019-DB
9. **Joss Daybed Right Arm**
M2019-RDB











RECOMMENDED SETS

LINEAR SOFA SET

DAYBED SOFA SET

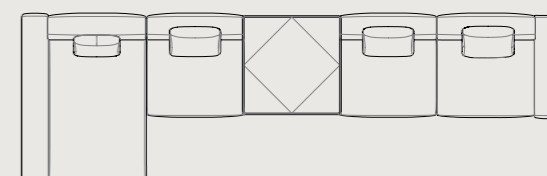
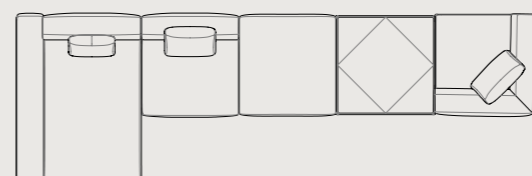
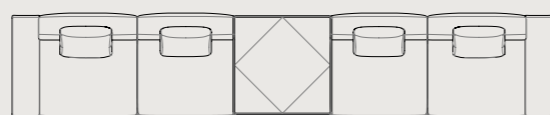
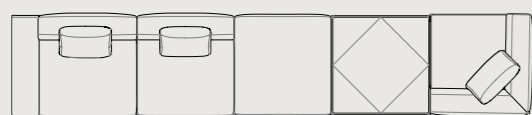
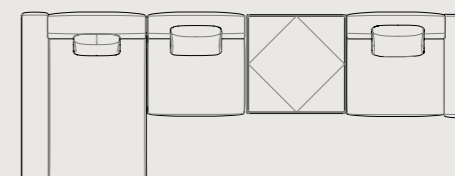
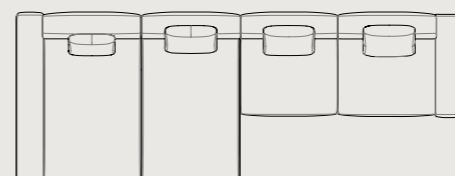
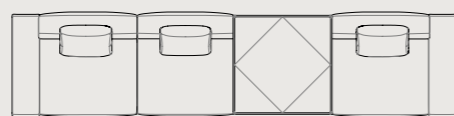
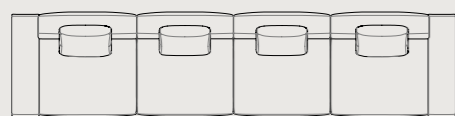
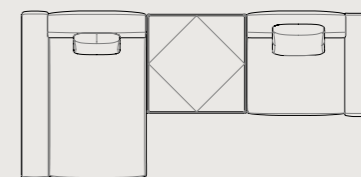
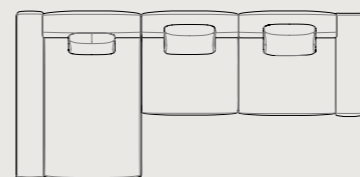
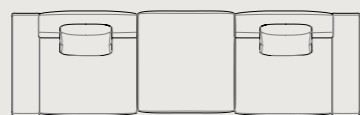
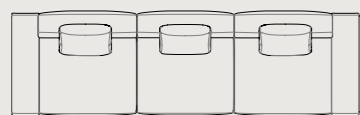
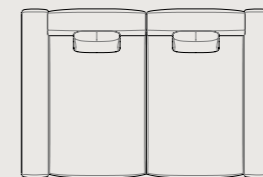
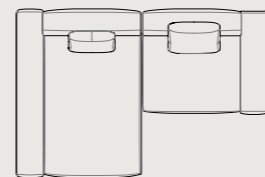
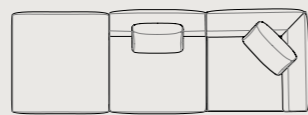
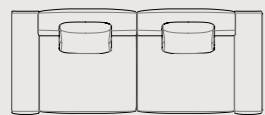

RECOMMENDED SETS

L-SHAPE SOFA SET

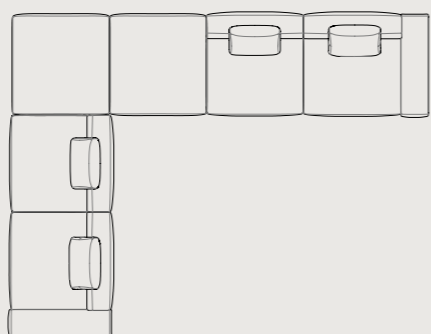
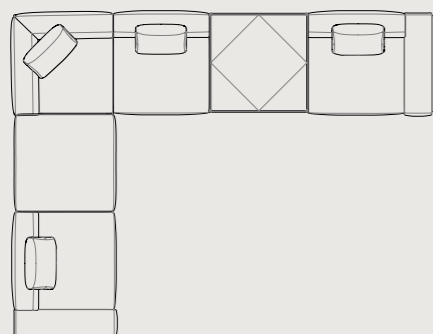
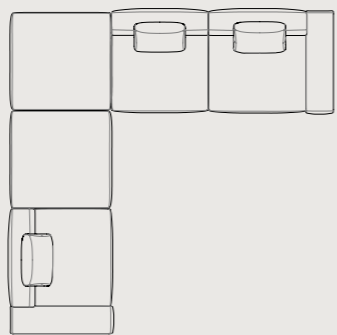
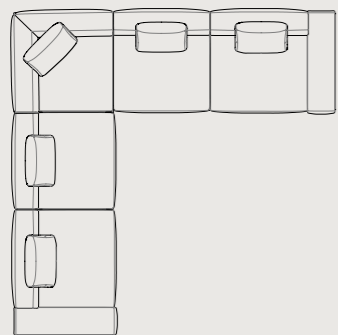
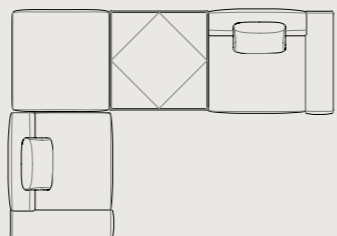
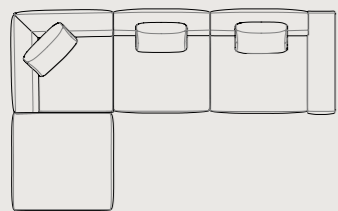

ISLAND & U-SHAPE SOFA

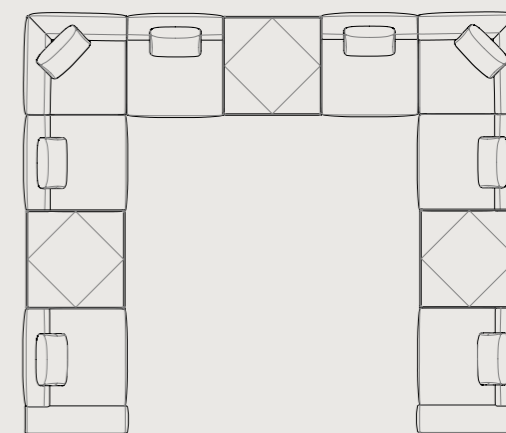
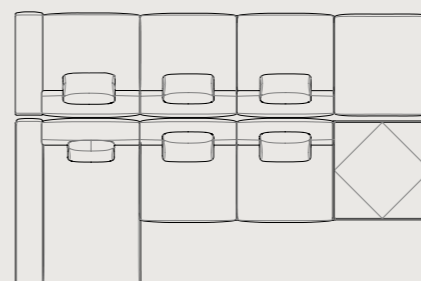
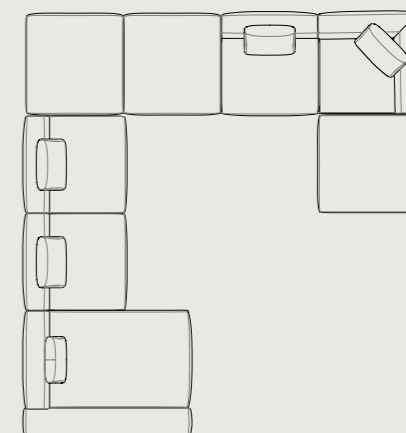
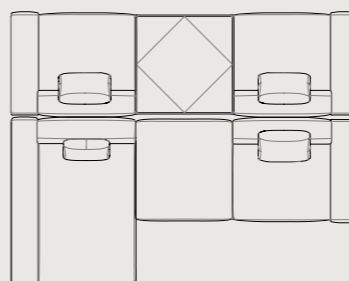
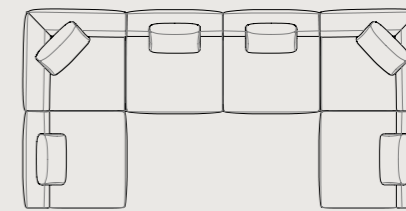
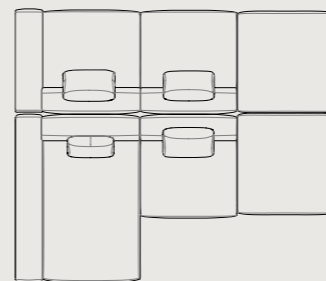

PROJECTING ELEMENTS

Joss 1 Seater Armless L103 W103 H67
M2019-NA

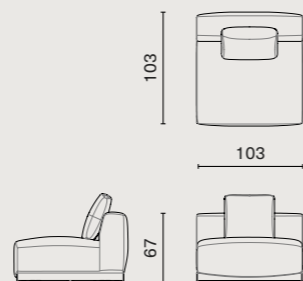

Joss 1 Seater Left Arm L130 W103 H67
M2019-LA

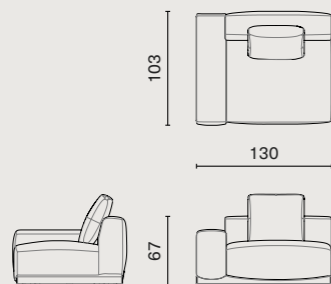

Joss 1 Seater Right Arm L130 W103 H67
M2019-RA

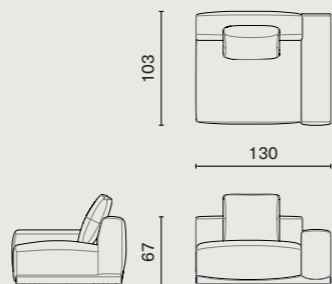

Joss Table L100 W100 H11
M1014

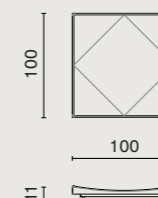

Joss Daybed Armless L168 W103 H67
M2019-DB

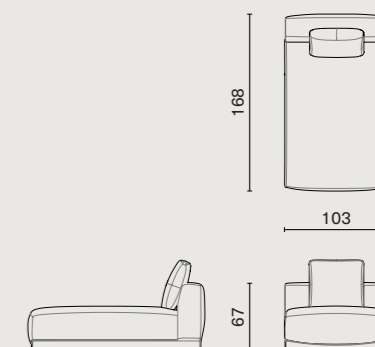

Joss 1 Seater Corner L103 W103 H67
M2019-C

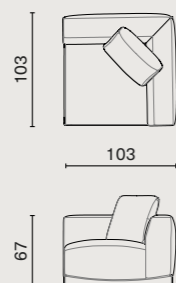

Joss Ottoman L103 W103 H44
M2019-O

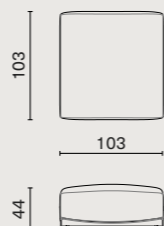

Joss Daybed Left Arm L168 W133 H67
M2019-LDB

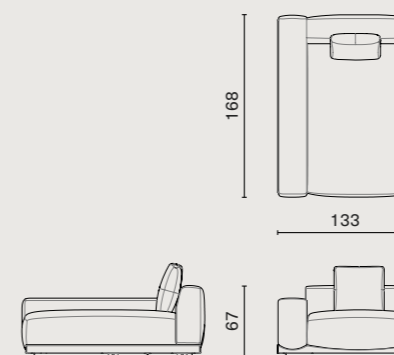

Joss Daybed Right Arm L168 W133 H67
M2019-RDB

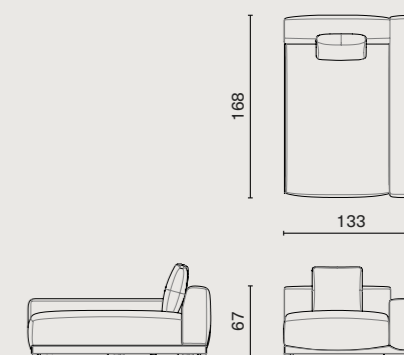



PROJECTING ELEMENTS / EXTENTION

Joss is, above all, a manifesto project of the high-quality craftsmanship acquired over the years by District Eight, which today integrates almost all the furniture trades and crafts for total control of the production process.

Complementary back-cushion which are made of fiber ball, foam and natural duck feathers.

*01 complementary back-cushion for each module, except for the Ottoman

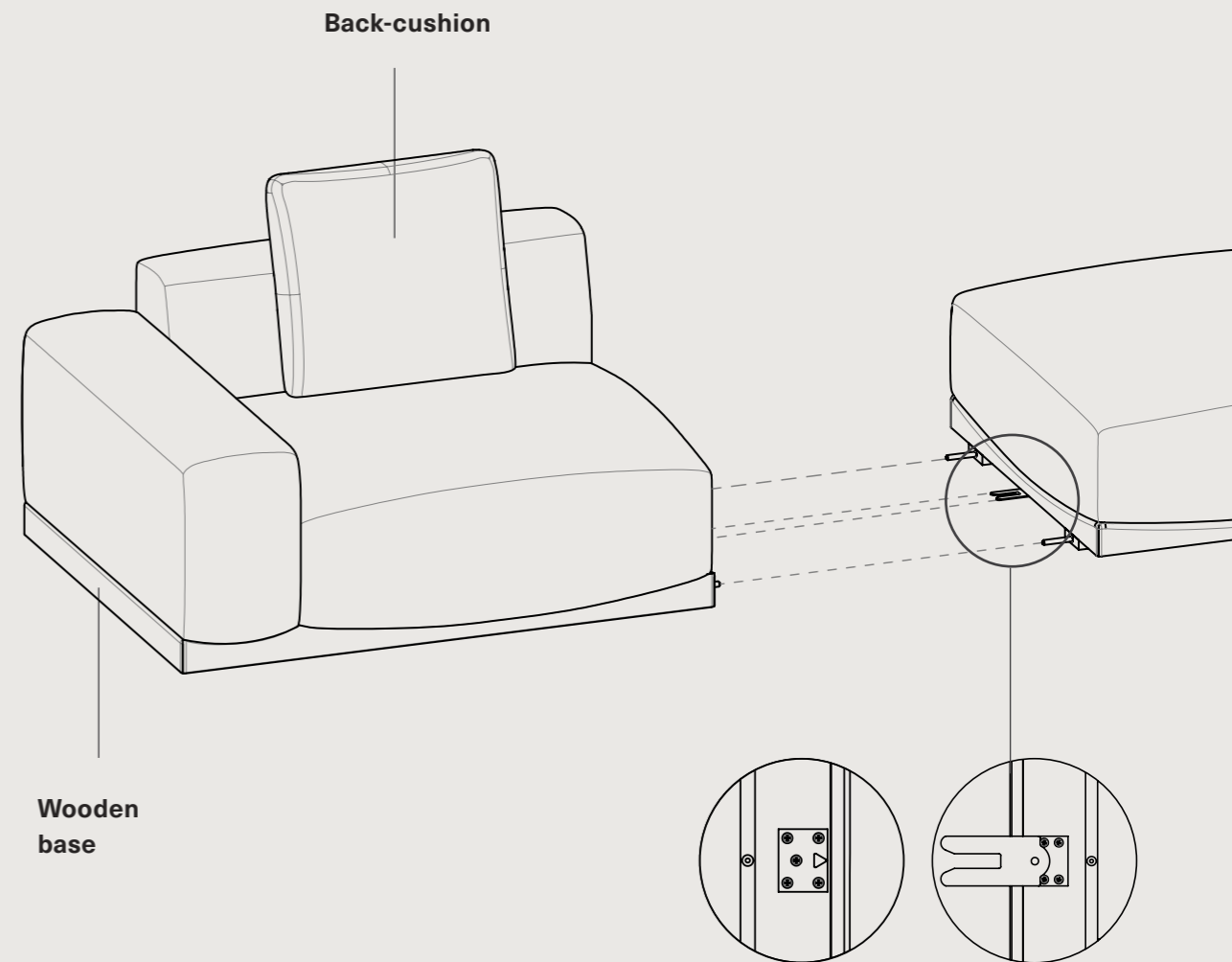

Alligator clips are provided for each modules to use as set-connecting hardware.

Alligator clip



Crafted From Ideas

The inspiration of District Eight often comes from pre-contemporary architecture, as it appears that until the middle of 20th century, furniture and objects were designed with a sense of purpose by architects themselves, rather than being mere disposable decoration.

Made, Manufactured, Crafted.

The ethos of District Eight design and production was established early on. Our products are made to be used reliably and to be durable through wear and tear, just like industrial tools or workwear would. This level of quality can only be achieved with the right balance of machinery and crafty hands.



Craft As Past, Present & Future

Our spaces are conceived to convey subtle elements of lifestyle. By working with rich textures, tonal color schemes, and curated artworks, District Eight aims at offering a unique experience, about craft and livability.

As the creative industries and the local environment evolve, District Eight has also made strides into new creative expressions and crafts. The “Crafted For Life” approach is developed especially for contemporary spaces, where private and public norms are converging.

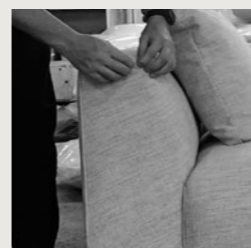
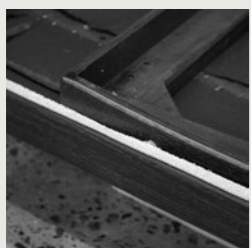
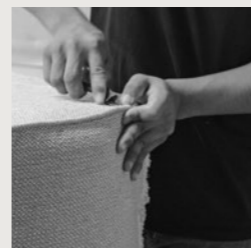
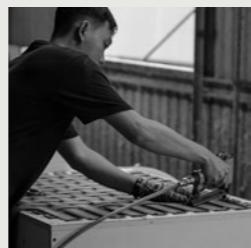
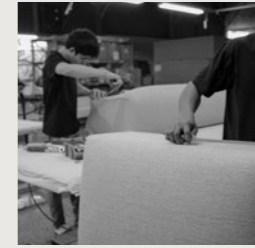
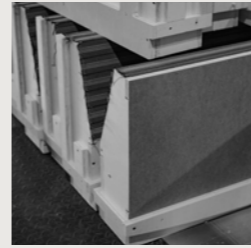
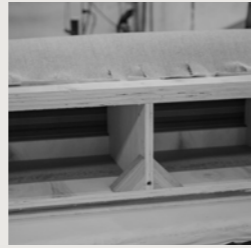

CRAFTED FOR LIFE.

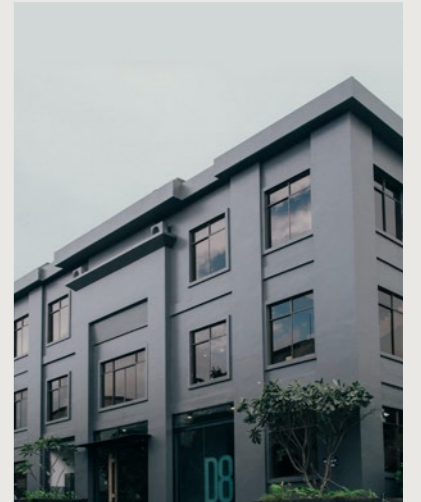

DISTRICT EIGHT DESIGN
FACTORY

E4/52, 1A Highway, Binh Tri Dong B Ward,
Binh Tan District, Ho Chi Minh City, Vietnam.

DISTRICT EIGHT POP-UP
SHOWROOM

33 Dong Khoi, Ben Nghe Ward,
District 1, Ho Chi Minh City, Vietnam.

(+84) 28 38 170 311

(+84) 28 38 170 312

Sales, projects, technical requests:
info@districteight.com

www.districteight.com